

OscilloWitt 3-6

The oscillating and rotating sieve mill for gentle size reduction of heat-sensitive and difficult products in the pharmaceutical, fine chemical and food industries

OscilloWitt 3-6

Milling process

DelumpWitt

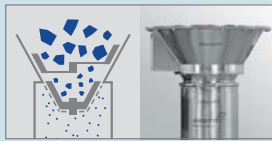

Particle size

60 cm

500 µm

Crusher

CC-310 · CCD-450



30 cm

2 cm

Oscillating sieve mill OscilloWitt 3-6

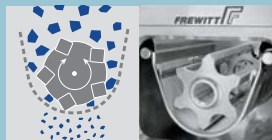

5 cm

250 µm

Conical sieve mill

ConiWitt 150-200-250 · TC-Lab



2 cm

150 µm

Rotary sieve mill

TurboWitt C20-C25

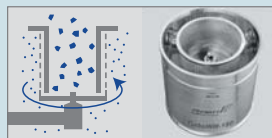

1 cm
to
1 mm

150 µm

Hammer mill

MFH-6 · MFH-15 · HammerWitt-Lab

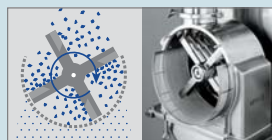

1 cm

30 µm

Excellent for narrow grain size spectrums and the grinding of heat sensitive products

The oscillating and rotating sieve mills of the OscilloWitt series are especially suited for the size reduction of heat-sensitive products and products that are difficult to process.

The OscilloWitt has been fundamentally redesigned and this results in a substantial increase in utility. The product is gently reduced in size through the infinitely adjustable oscillating or rotating rotor movement, the ever-constant speed and the force exerted. During the milling process, the granules are gently moved through the sieve openings, which reduces the heating of the product to a minimum.

The advantages are obvious

- The milling process can be optimised in either rotating or oscillating mode.
- The rotor speed is infinitely adjustable.
- The intelligent design reduces the number of moving parts as well as their weight to a minimum.
- The discharge plate can be replaced without removing the inlet funnel.
- Homogeneous interior of the mill, easy cleaning, no cracks.
- Inlet funnel with a Tri-Clamp connection.
- The outlet funnel is seamlessly integrated into the milling chamber preventing accumulation of the product.

Wide range of applications

It functions as a stand-alone system and can be easily integrated into production facilities.

The OscilloWitt is primarily used for sophisticated milling of products that are difficult to process in the pharmaceutical, fine chemical and food industries.

The large swing front doors allow user-friendly installation and removal of the sieve, rotor and rigid screen support.

The innovative door guide and continuous door seal permits the OscilloWitt to be used at the highest containment level (tightness).



The OscilloWitt sets new Standards



The OscilloWitt consists of a rotor, sieve, sieve tensioner or rigid screen support. The oscillating or rotating cyclical movement causes the passage of the product through the sieve. The functionality of the OscilloWitt and the applied use of the milling forces are particularly suited to the gentle milling of products that are heat-sensitive and difficult to process, and the production of narrow grain size spectrums tolerances without fine materials.

- 1 Oscillating or rotating rotor
- 2 Various sieve inserts for dry or wet milling (round wire/square wire/rasp and perforated plate)
- 3 The sieve can be tensioned directly by using a sieve tensioner (classic mode of operation)
- 4 Rigid screen support for adjusting the distance between rotor/sieve
- 5 Security check at the inlet funnel (cables laid internally)
- 6 Milling area with optimised surface and front access for easy handling and easy cleaning.

Milling forces



Comminution in the OscilloWitt is achieved primarily by shearing and comminution of the particles between the sieve and the oscillating or rotating rotor at a relatively low level of force.

The OscilloWitt in detail

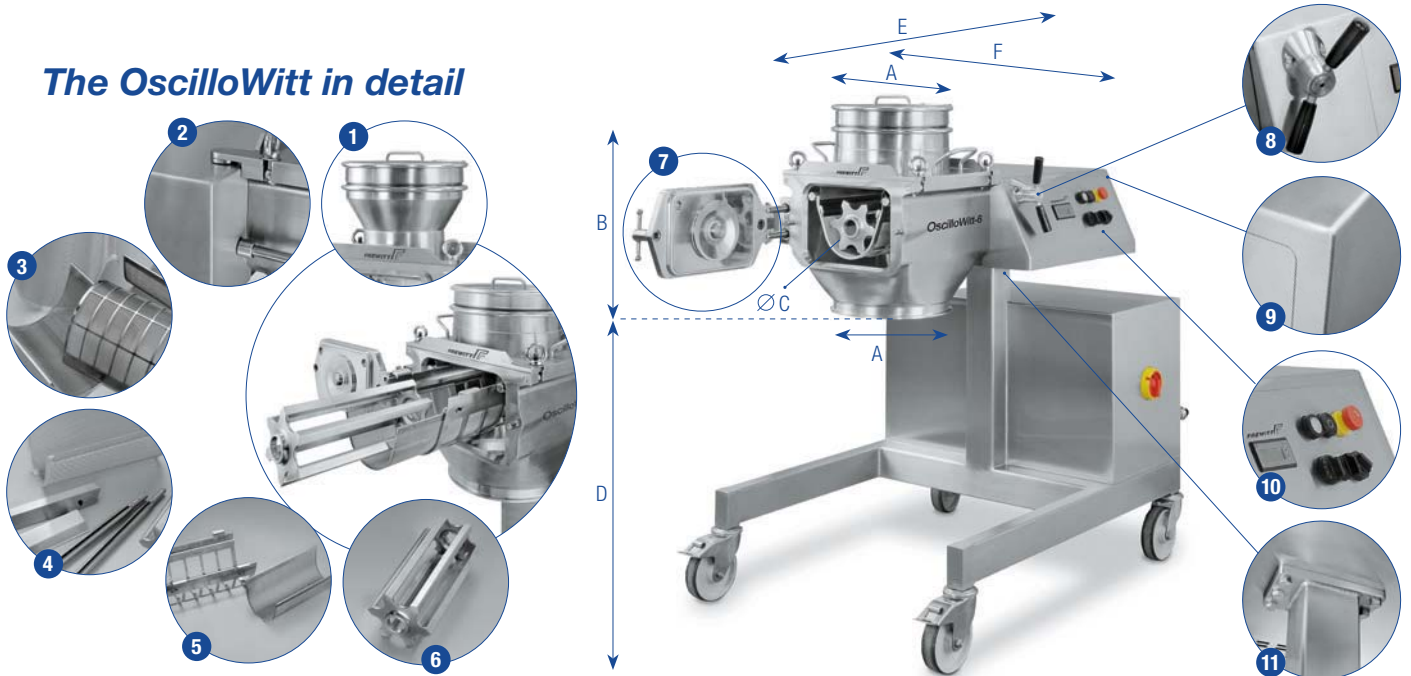

OscilloWitt at a glance

- 1 Inlet funnel with a protective grill
- 2 Security check at the inlet funnel and doors (default) no external cable
- 3 Large selection of different sieve types (round wire/square wire/rasp and perforated plate)
- 4 Sieve tensioner for direct tensioning of the sieve (classic mode of operation)
- 5 The use of the rigid sieve support and the correct adjustment of the distance between the rotor and sieve prevents contact between metal parts
- 6 Rotor with six arms
- 7 O-ring seal on doors for highest level of containment
- 8 Relevant process parameters can be seamlessly documented
- 9 No screws on the cover
- 10 LCD speed display in m/s
- 11 Easy attachment
 - Sieve with round wire for the size reduction of products that are easy to break down
 - Sieve with square wire for hard products
 - Fine sieves for wet grinding
 - Multi-function mill thanks to quick setting of the milling process to oscillating or rotating

Installation	B	C	D	E	F	A - INFEED	A - DISCHARGE	
OscilloWitt-3	477.5	∅Rotor=160	1000.5	1304.39	888	∅213.9	∅213.9	
OscilloWitt-6	472.5	∅Rotor=160	1015.5	1304.39	888	∅315.9	∅315.9	
Installation	Flow rate*		Voltage		Speed		Power	Net weight
OscilloWitt-3	600 kg/h		400V – 50Hz		0 – 1.35 m/s		1.8 kW	340 kg
OscilloWitt-6	1000 kg/h		400V – 50Hz		0 – 1.35 m/s		1.8 kW	370 kg

* The throughput is dependent upon the product and grain size.

Advantages

Ergonomic and easy to use

- Modular, compact design
- The rotor, sieve and rigid screen support can be installed and removed in only a few simple steps due to the large, swinging front doors
- With a few simple steps it is tightly closed in a few seconds, thanks to optimal closures
- All relevant process parameters can be read and documented (distance between rotor/sieve, product temperature, rotor speed, etc.)
- Installation through the wall (clean room)
- On a mobile base, if required

Cleaning according to the strictest health standards

- SIP sterilisation is possible
- The milling head is made of AISI 316L stainless steel. The ground, homogeneous surfaces support the smooth and residue-free flow of the product
- The OscilloWitt meets the requirements both for "Washing in Place", (WIP) and those for CIP cleaning
- Fast, safe cleaning, thanks to internal routing of cables
- Pressure shock resistant design possible
- Improved sealing through continuous seals and an integrated outlet funnel

Less maintenance and greater workplace safety

- Simple, intuitive, low maintenance construction
- International Customer Service
- Quick delivery service of spare parts
- Security check at the front door and hand protection at the outlet
- ATEX to zone 0/20 inside, zone 1/21 outside is possible
- Rotor/sieve speed control (from 0 to 1.35 m/s)



Only use original wear and spare parts from Frewitt. The use of non-original Frewitt parts can lead to dangerous situations that may result in an explosion or injury and therefore invalidates the ATEX certificate.



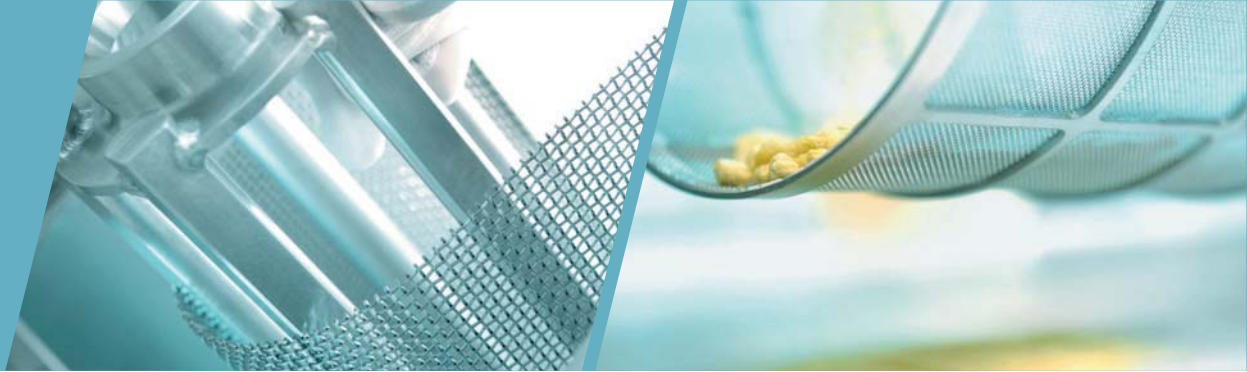

High flexibility and optimal results in size reduction

- With a few simple steps, the specific exchange of sieves can be carried out through the large, swinging front doors, so the milling process can be adjusted for dry or wet milling.
- Thanks to a large selection of sieves, as well as setting the rotor to oscillating or rotating, the grinding process can be adjusted to suit every conceivable product.
- The adjustable speed/oscillation prevent heating of the product.
- Consistent processing of the product can be ensured thanks to the LCD speed setting m/s.
- Using the new technology in rotor movement; the ever-constant speed and the large active sieve surface, the product is gently processed, thus the percentage of fine materials remain very small.
- The OscilloWitt can be used as a stand-alone system and, thanks to the new design, it integrates more easily into a production facility.
- Head and the motor are built separately, which allows installation through the wall (clean room).



Construction	Parts in contact with the product	Parts not in contact with the product
Metals	1.4435 / 1.4404 (AISI-316L)	1.4301 / 1.4305 (AISI-304)
Seals	FDA compliant plastics (EPDM / PTFE)	Various plastics
Surface finish	Ra ≤ 0.8 µm polished / Head Ra ≤ 0.4 µm polished	Head Ra ≤ 1.4 µm polished
Weld seams	Ground und polished	Treated and brushed
Rotor	Rotor with 6 arms	
Sieve types	Dry milling: round or square wire/wet milling: fine sieve, round wire	
Distance rotor / sieve	Adjustable via locking mechanism	
Rotor speed	Infinitely adjustable	

Options for custom-made solutions

Inlet funnel		Outlet funnel	
Silicone collar	Compensator	ProFi-Bant (Holding Device pneumatic)	ProFi-Lun (Holding Device manual)
OscilloWitt-3 ∅250/315	DN 100 DN 250	OscilloWitt-3 DN 200/300	OscilloWitt-3 DN 200/300
OscilloWitt-6 ∅315	DN 150 DN 300	OscilloWitt-6 DN 200/300	OscilloWitt-6 DN 200/300
	DN 200		

Control options

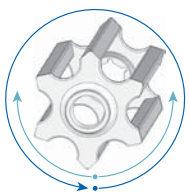

Option: Pack 1

- Variable rotation / oscillation speed
- Switching from rotation to oscillation

Oscillation with a superimposed light rotation ensures that the rotor is used uniformly on all sides. Thus a longer operating life is possible.

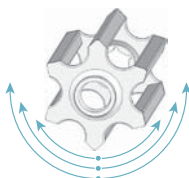

Option: Pack 2

- Changing the oscillation amplitude via a potentiometer
- Greater angle in the milling area

Oscillation with a superimposed light rotation ensures that the rotor is used uniformly on all sides. Thus a longer operating life is possible.

Type of tools



Sieve insert with a rigid screen support



Sieve insert with direct sieve tensioner

- On a mobile base
- SIP sterilisation is possible
- Pressure shock resistant design
- Speed control (from 0 to 1.35 m/s)
- ATEX to zone 0/20 inside, zone 1/21 outside is possible



A particle sizing system in universal application

The redevelopment of the OscilloWitt makes "Frewitting", even more successful. Both dry and wet products, as well as those that are heat-sensitive and difficult to process, can be reduced in size and dosed through the oscillation or rotation of the rotor.

The OscilloWitt can be used for the production of small quantities, as well as for large-scale production in batch or in-line operations, as standard or customized execution in the pharmaceutical, fine chemicals and food industry.

The OscilloWitt is reliable in processing and fast in processing, protecting the user, as well as the product and also ensures a reduction in production costs. The OscilloWitt - a sieve mill of a very special kind, able to grow with your needs.



Stand-alone OscilloWitt in ATEX construction



Can be integrated into installation with the DelumpWitt crusher module



Quick and easy handling of the OscilloWitt is ensured thanks to the large front door



OscilloWitt with LCD speed display

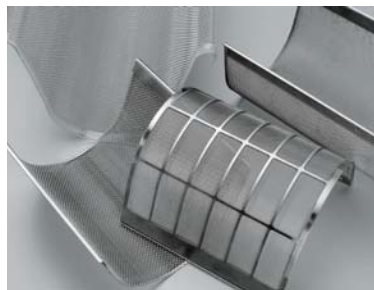

Various sieve inserts for dry or wet milling (round wire/square wire/rasp and perforated plate)



OscilloWitt integrated into the process flow

Thanks to the modular design of the OscilloWitt, it can be integrated quickly and easily anywhere. Call us to discuss your application.

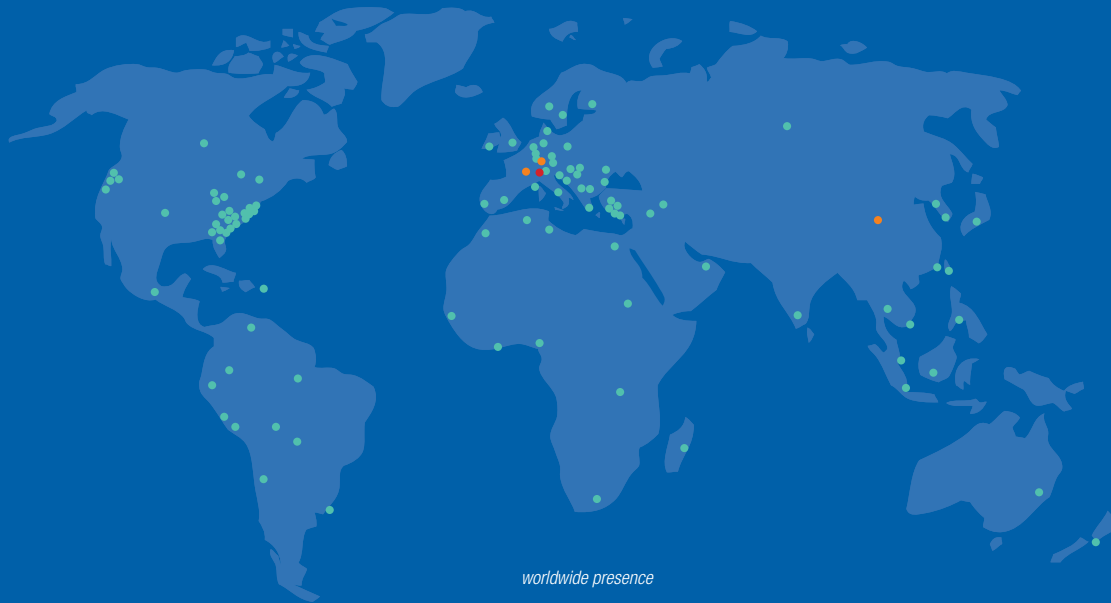

worldwide presence

References

AstraZeneca AB
 Bayer AG
 BASF AG
 Sandoz GmbH
 Ciba Spezialitätenchemie AG
 Cilag AG
 Clariant International Ltd

Colman's of Norwich
 DE-VAU-GE Gesundkostwerk GmbH
 Dolisos France and Italy
 F. Hoffmann-La Roche AG
 Ferring International Center SA
 Firmenich SA
 Sanofi-Aventis Deutschland GmbH

McCormick
 Natura Cosmetica
 Nestlé SA
 Novartis Consumer Health SA
 Novartis Crop Protection AG
 BASF Monthey SA
 Reckitt & Colman (Unilever)

Schering AG
 Siegfried CMS AG
 UCB Farchim SA
 Uelzerna Milchwerke eG
 Ultra Precision SA
 ect.



Frewitt SA
 Route du Coteau 7
 CH-1763 Granges-Paccot
 Postal address:
 Box 615
 CH-1701 Fribourg
 Switzerland
 T +41 (0)26 460 74 00
 F +41 (0)26 460 74 01
 info@frewitt.com
 www.frewitt.com



Frewitt SA
 Route du Coteau 7
 CH-1763 Granges-Paccot
 Postal address:
 Box 615
 CH-1701 Fribourg
 Switzerland
 T +41 (0)26 460 74 00
 F +41 (0)26 460 74 01
 info@frewitt.com
 www.frewitt.com



Frewitt Printing SA
 Route André Piller 43
 CH-1720 Corminbœuf/Fribourg
 Switzerland
 T +41 (0)26 460 74 20
 F +41 (0)26 460 74 21
 printing@frewitt.com
 www.frewitt.com/printing

Address:

